

Podium Steps

BS 8620:2016

Width (W)	Length (L)	Working Height (wh)	Tower Height (H)	Platform Height (ph)
0.65m	1.37m	3.0m	2.01m	1.0m

Tower Components

Item	Description	Quantity
1	Podium Mainframe	1
2	Self Closing Gates	1
3	Platform	1
4	Stabilisers	2
5	Ladder	1
6	Instruction Manual	1

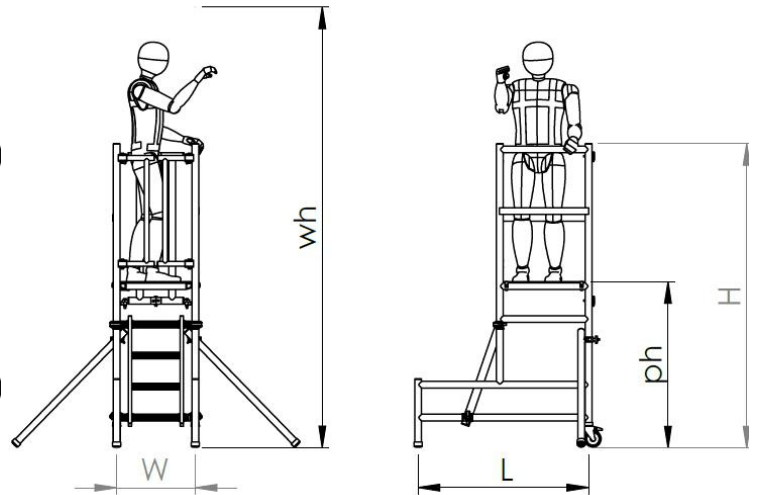
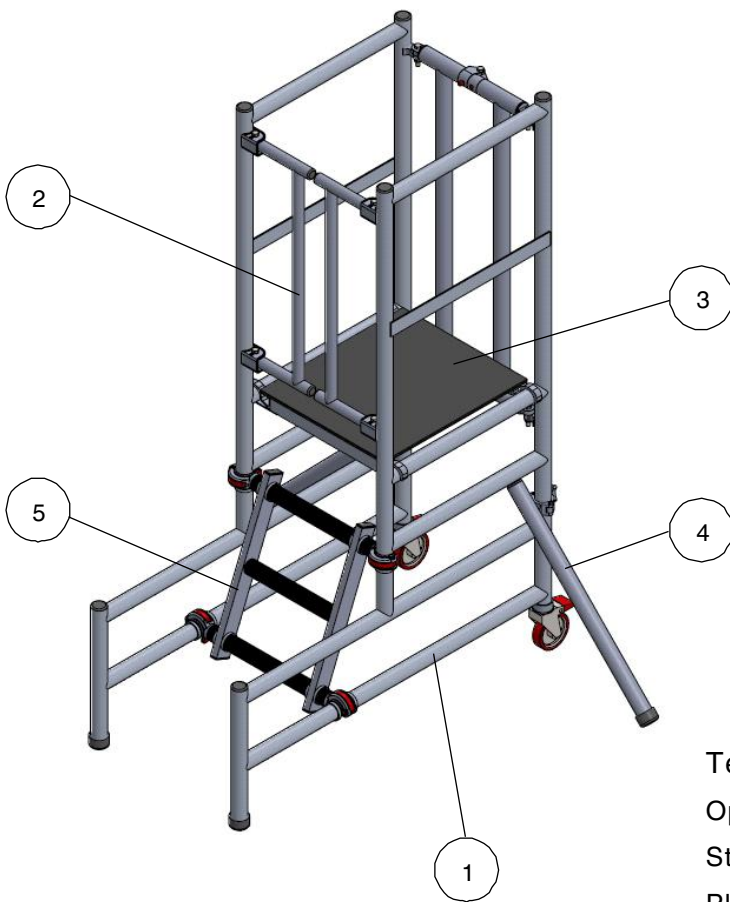

Technical information:

Open Dimensions:	(H)2.01 X (L)1.37m X (W)0.65m
Storage Dimensions:	(H)2.01 X (L)1.37m X (W)0.26m
Platform Dimensions:	0.6m X 0.53m
Platform Height (ph):	0.75m 1.0m
Working Height (wh):	2.75m 3.0m
Maximum Working Load:	150kg
Weight:	33kg



Aluminium Scaffold Towers Ltd.

☎ 01353 778811

✉ sales@aluminium-scaffoldtowers.co.uk

🌐 www.aluminium-scaffoldtowers.co.uk